

NO PROBLEM, IT'S HYDROCORK.

WATERPROOF | IDEAL FOR RENOVATIONS | [SILENCE](#)
[PET FRIENDLY](#) | NATURAL THERMAL INSULATION | WALKING COMFORT

hydracork READY FOR REAL LIFE

wood

stone



WICANDERS®

Nature at your feet

hydracork

ONE FLOOR FITS ALL SPACES

Hydrocork is available in a beautiful range of realistic wood and stones visuals that provide all the benefits of the Corktech technology. Hydrocork is 100% waterproof which means that it can be used in all areas including bathrooms and kitchens! It is such a premium product that Wicanders provides a Lifetime Warranty for Residential usage.



MADE IN PORTUGAL

Light Grey Marble

WOOD LOOKS

Hydrocork is available in 27 natural look and feel visuals. Twenty in a plank format of 1225 x 145 mm, and seven in 1225 x 195 mm. Featuring a 0,55mm wear layer that provides a remarkable enduring beauty, and with only 6mm of thickness, it is the perfect choice for renovation projects since Hydrocork can be installed on top of a previously existing floor.



Linen Cherry | B5R0001 4



Sawn Bisque Oak | B5P3001 4



Sand Oak | B5R1001 4



Chalk Oak | B5Q1001 4



Light Beech | B5T0001 4

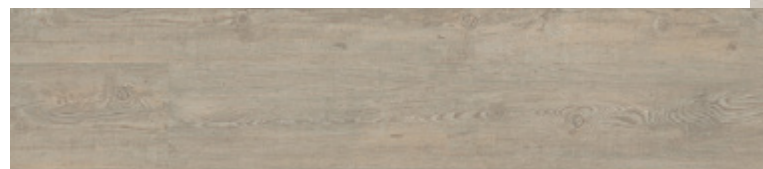

Wheat Pine | B5R3001 4



Claw Silver Oak | B5V3001 4

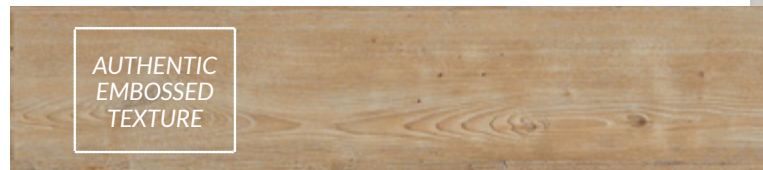

Arcadian Soya Pine | B5P4001 4



Alaska Oak | B5Q0001 4



Castle Raffia Oak | B5P0001 4



Limed Grey Oak | B5T7001 4



European Oak | B5Q2001 4

4 4 sides micro beveled

STONE LOOKS

Hydrocork has 6 natural realistic visuals featuring also a 0,55mm wear layer that offers high resistance and durability. Available in a board format of 615 x 295 mm and with only 6mm of thickness, it is the ideal choice for renovations projects.

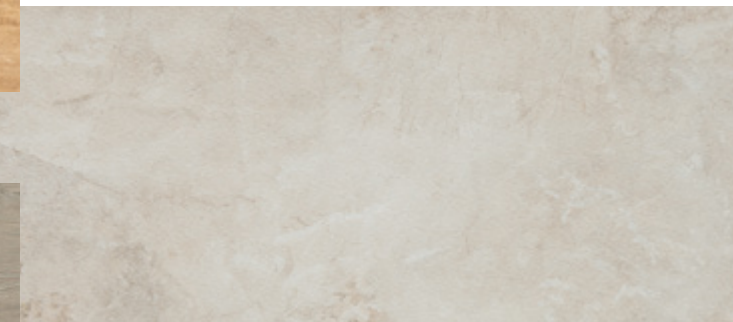
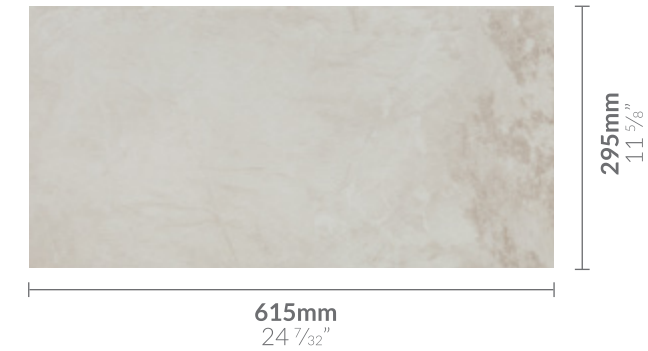

Beige Marble | B5XV001 4



Jurassic Limestone | B5XS001 4



Light Grey Marble | B5XW001 4



Graphite Marble | B5XX001 4



Chalk Grey Stone | B5V6001 4



Dark Beton | B5V5001 4

4 4 sides micro beveled

WOOD LOOKS

Hydrocork is available in 27 natural look and feel visuals. Twenty in a plank format of 1225 x 145 mm, and seven in 1225 x 195 mm. Featuring a 0,55mm wear layer that provides a remarkable enduring beauty, and with only 6mm of thickness, it is the perfect choice for renovation projects since Hydrocork can be installed on top of a previously existing floor.



Linen Cherry | B5R0001 4



Sawn Bisque Oak | B5P3001 4



Sand Oak | B5R1001 4

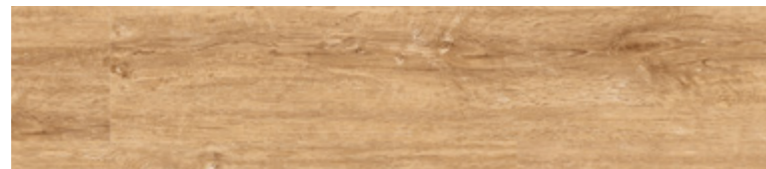

Chalk Oak | B5Q1001 4



Light Beech | B5T0001 4

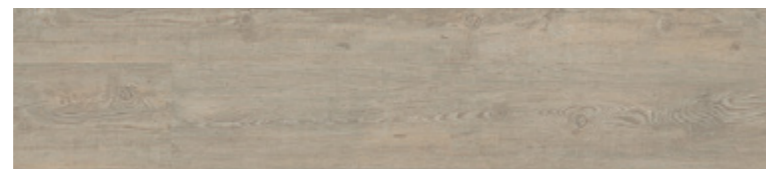

Wheat Pine | B5R3001 4



Arcadian Rye Pine | B5P5001 4

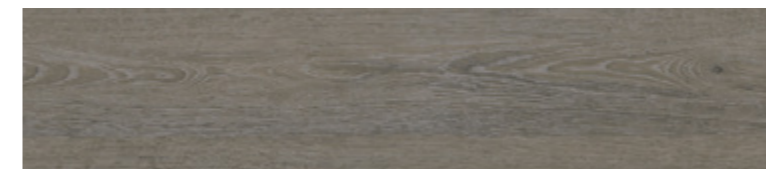

Cinder Oak | B5R7001 4



Sylvan Gold Oak | B5L8001 4



Rustic Grey Oak | B5WV001 4



Claw Silver Oak | B5V3001 4

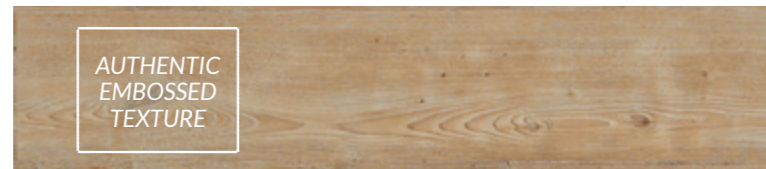

Arcadian Soya Pine | B5P4001 4

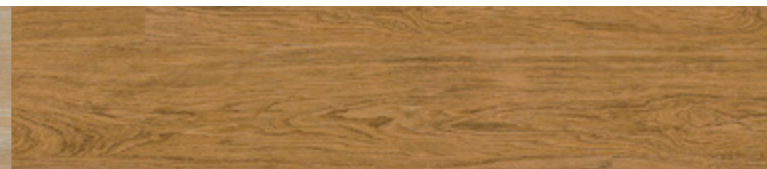

Nature Oak | B5T5001 4

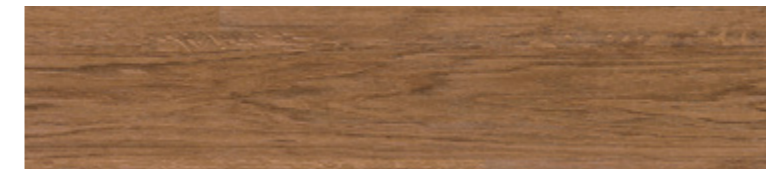

Elegant Oak | B5R4001 4



Alaska Oak | B5Q0001 4



Castle Raffia Oak | B5P0001 4



Castle Toast Oak | B5P1001 4

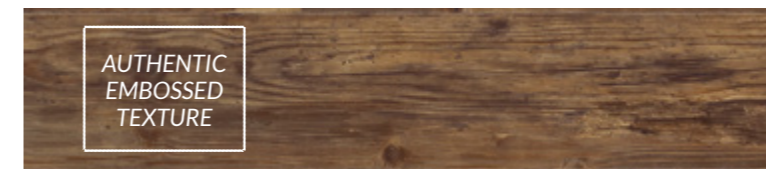

Century Fawn Pine | B5P7001 4



Limed Grey Oak | B5T7001 4



European Oak | B5Q2001 4



Sawn Twine Oak | B5P2001 4

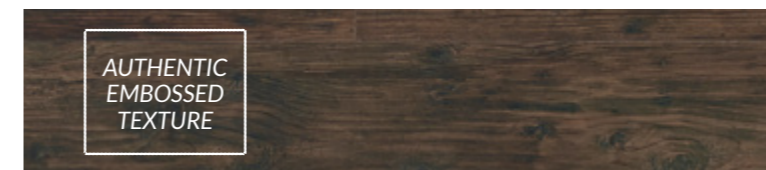

Century Morocco Pine | B5P6001 4



4 4 sides micro beveled

4 4 sides micro beveled

Arcadian Arctic Pine



100% WATERPROOF



DURABLE, RESISTANT

AND EASY TO MAINTAIN

The elasticity and resilience of Hydrocork's cork layer create a floor that is adaptable to pressure, adding the capacity to absorb, resist and recover from violent impacts. The surface is made with a protective wear layer making easy to clean.



MORE THAN JUST A BEAUTIFUL FLOOR



Hydrocork is a low thickness floating solution with a core board made of composite cork that can be placed in any indoor space without boundaries. Ideal for renovations, Hydrocork is also 100% waterproof, incredibly stable, durable, great noise absorber, and thermal insulator - all due to the unmatched cork properties.



SILENCE

Hydrocork can act as a noisy buffer between the floor and the rooms underneath reducing the walking sound up to 53%.



NATURAL THERMAL INSULATION

Hydrocork maintains an optimal temperature throughout the year, the cork composite layer preserves energy making the floor and the room warmer without the need of heaters.



WALKING COMFORT

Hydrocork inherent flexibility provides a unique comfort and movement even and walking barefoot, a sense of coziness, relaxation and enjoyment is felt.



IMPACT RESISTANT

Hydrocork it's a high shocking absorber maintaining it's resistance at the same time. It's a very robust flooring with a long life span.

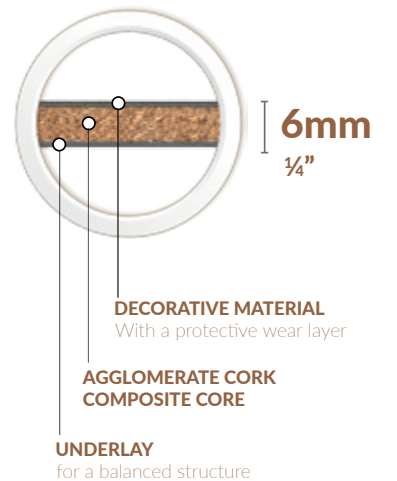

EASY AND FAST INSTALLATION

STABLE AND STRONG INSTALLATION WITH **PRESSFIT** COMPRESSION SYSTEM

PressFit is a revolutionary compression system that takes full advantage of the amazing cork properties - flexibility, elasticity and compressibility - functioning like a cork stopper

Hold two planks side by side.

1st STEP

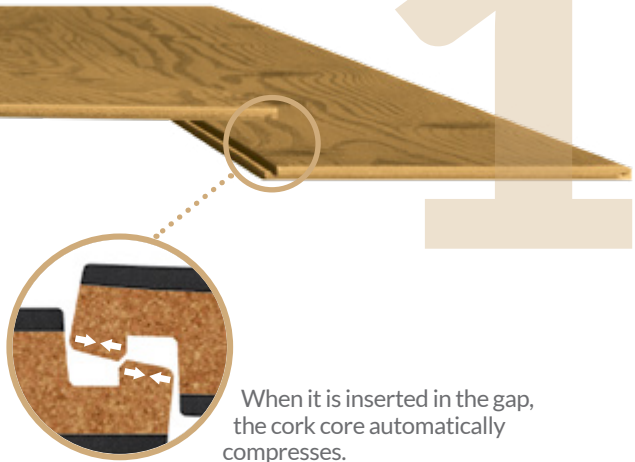

When it is inserted in the gap, the cork core automatically compresses.

2nd STEP

Press down along the joint with the help of a white rubber hammer.

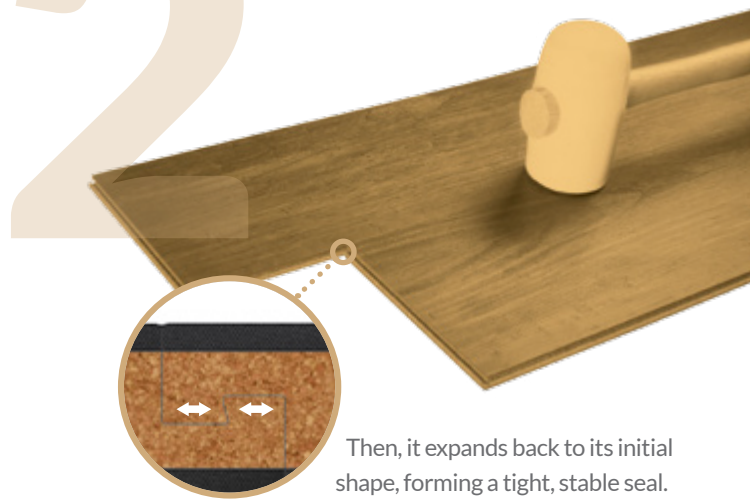

Then, it expands back to its initial shape, forming a tight, stable seal.



REDUCED INSTALLATION COSTS

Hydrocork is only 6mm thick making it easy to cut. Avoids the need to remove the existing skirtings or to cut doors and it can be easily installed on top of other flooring materials.



LIMITED
LIFETIME
WARRANTY

Arcadian Rye Pine



Low Telegraphing Effect



Remarkable Realism



Suitable for Subfloor Heating

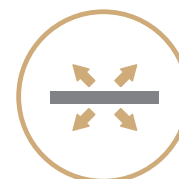

Dimensional Stability



* Please see the terms and conditions of Wicanders Limited Warranty in the website.



AMORIM

HeadQuarters

Amorim Revestimentos S.A

(+351) 227 475 600

geral.ar@amorim.com

DE	Amorim Deutschland GmbH (+49) 4221 5 93-01	germany.ar.de@amorim.com
BE NE LUX	Amorim Benelux B.V. (+31) 166 604 111	info.ar.nl@amorim.com
AT	Amorim Deutschland GmbH (+43) 1 54 51 65 10	austria.ar.de@amorim.com
CH	Amorim Flooring Switzerland AG (+41) 41 726 20 20	info@amorim.ch
PT	Amorim Revestimentos, S.A. (+351) 227 475 600	geral.ar@amorim.com
ES	Amorim Revestimentos, S.A. (+34) 902 307 407	info.ar.es@amorim.com
FR	Amorim Revestimentos, S.A. (+33) 800 914 848	info.ar.fr@amorim.com
DK	Timberman Denmark A/S (+45) 995 252 52	timberman@timberman.dk
PL	Dom Korkowy, Sp. z o.o. (+48) 126 379 639	krakow@domkorkowy.pl
US	Amorim Flooring North America (+1) 410 553 60 62	info.ar.us@amorim.com
RU	Amorim Flooring Rus, OOO (+7) 495 280 7860	info.ar.ru@amorim.com
SW	Amorim Flooring Sweden +46 (0) 31 107740	order.se@wicanders.com

www.wicanders.com

